

Gravity Separator

IPMA INDUSTRY SDN. BHD.

益马工业有限公司

198501004398 (136837-P)



Model: GS-4

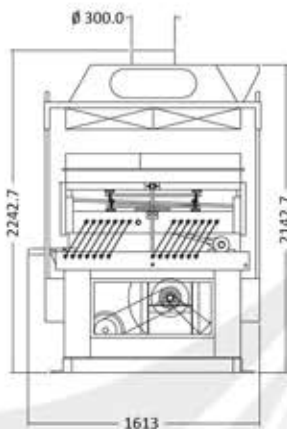

FRONT VIEW

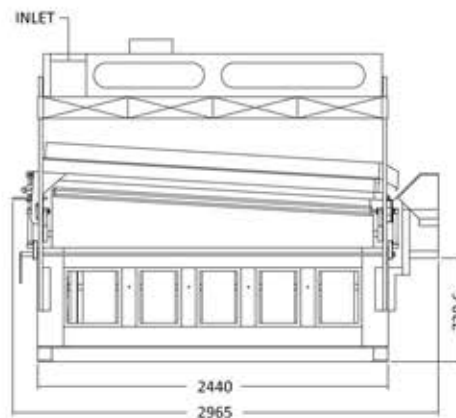

SIDE VIEW

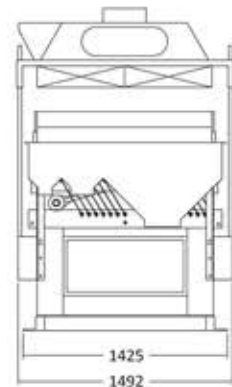

BACK VIEW

Model	Output Capacity	Deck Size (M)	Power Requirement	Dimension(MM) (L x W x H)
GS-4	3 - 4 TPH	1.07 m x 2.29 m	7.5 KW	2965 x 1613 x 2243

www.ipmaindustry.com

Details provided about the properties and usability of the products are purely for information purposes and do not constitute a guarantee of these characteristics. The extent of goods delivered and services performed is determined by the subject matter of the specific contract. No liability accepted for errors or omissions.

IPMA

Your One Stop Rice Processing And Solution Centre!

Gravity Separator

IPMA INDUSTRY SDN. BHD.

益马工业有限公司

198501004398 (136837-P)



Model: GS-5



Model	Fan Drive	Reciprocating Drive
GS-5	6.0 KW	2.2 KW

www.ipmaindustry.com

Details provided about the properties and usability of the products are purely for information purposes and do not constitute a guarantee of these characteristics. The extent of goods delivered and services performed is determined by the subject matter of the specific contract. No liability accepted for errors or omissions.

IPMA

Your One Stop Rice Processing And Solution Centre!

Gravity Separator

IPMA INDUSTRY SDN. BHD.

益马工业有限公司

198501004398 (136837-P)



Model: GS-10



Model	Input Capacity	No of Fan & Fan Drive	Reciprocating Drive	Vertical Tilt Adjustment	Horizontal Tilt Adjustment	Table Area	Air Requirement	Dimension(MM) (L x W x H)
GS-10	10 TPH	2 x 7.5 KW (1440 rpm)	2.2 KW (910 rpm)	0° to 6°	3° to 6°	5.39 M ²	32,400 M ³ /H	4290 x 1840 x 1580

www.ipmaindustry.com

Details provided about the properties and usability of the products are purely for information purposes and do not constitute a guarantee of these characteristics. The extent of goods delivered and services performed is determined by the subject matter of the specific contract. No liability accepted for errors or omissions.

IPMA

Your One Stop Rice Processing And Solution Centre!

Gravity Separator

IPMA INDUSTRY SDN. BHD.

益马工业有限公司

198501004398 (136837-P)



Model: GS-40

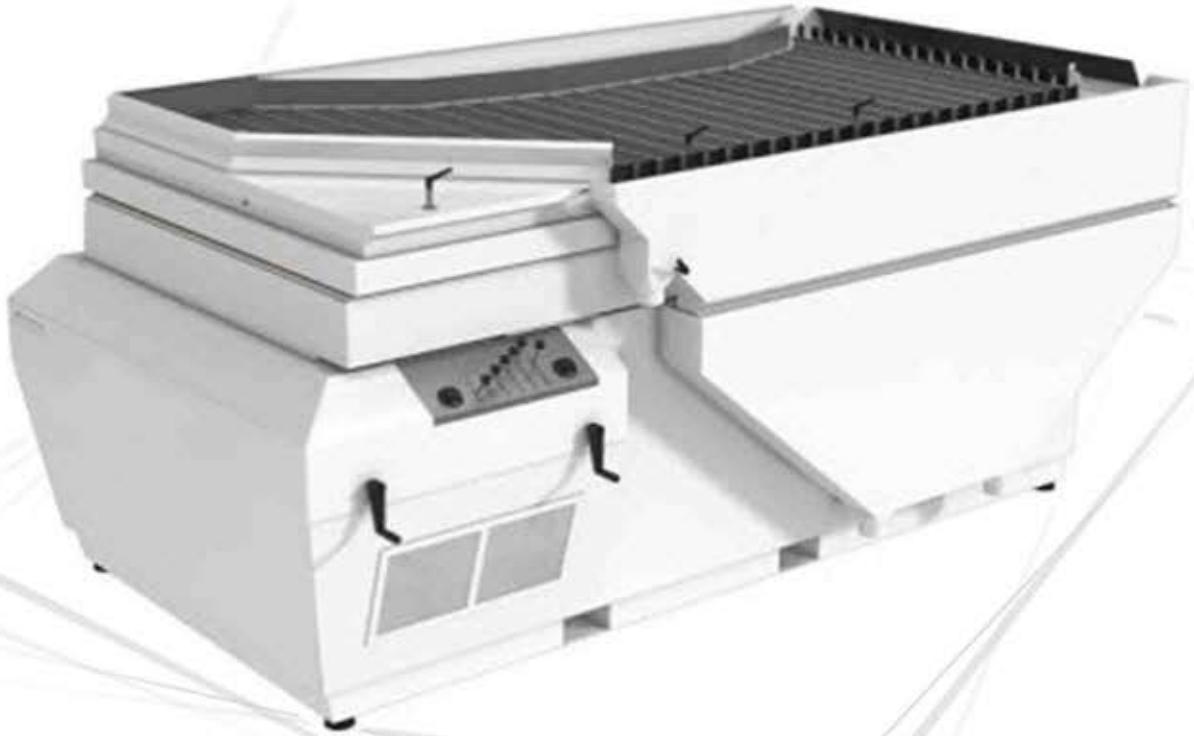

TOP VIEW

FRONT VIEW

SIDE VIEW

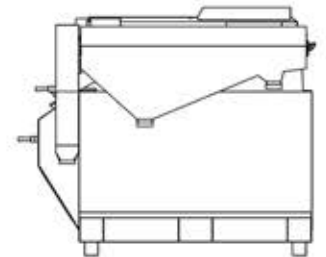
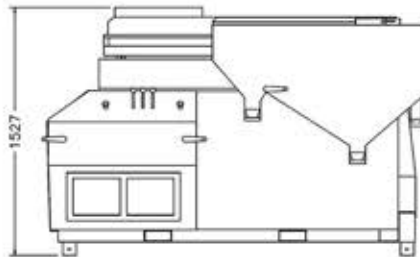
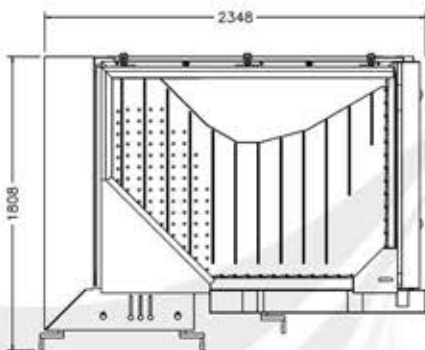

Model	Screen Area	Capacity	Motor Reciprocating	Motor Fan
GS-40	2.3 M ²	3.0 - 4.0 TPH	1.10 KW	7.5 KW

www.ipmaindustry.com

Details provided about the properties and usability of the products are purely for information purposes and do not constitute a guarantee of these characteristics. The extent of goods delivered and services performed is determined by the subject matter of the specific contract. No liability accepted for errors or omissions.

IPMA

Your One Stop Rice Processing And Solution Centre!